

A Precision 2" Nom. Swage Press for the production of hose assemblies of all types.

Designed specifically for portability, with versatile single phase supply and Super Charged for Rapid Operation. Express Control enables use of Colour Coded Dies with Automatic Die Selection with Imperial or Metric Inputs. Every Crimp is measured and checked.

- **2" 6 Wire Hydraulic hose capability**
- **Shoe Cluster Auto Indexing - Auto Lubrication**
Constant >97% Crimping Efficiency
- **Dies Without Pins**
- **Automatic Measure + Re-Crimp + Re-Measure**
- **Super Charging... 3 x Quicker Operation.**
- **220/110 VAC Single Phase- Worldwide Supply**
- **Express Control with Auto Die Set Selector**
- **Standard swaging range 16 to 78mm diam.**
Extended swaging range 6.5 to 100mm diam.
- **UL and CE approvals**

Dynamic:

Nom. Size (Hydraulic Hose Size Inches).....	2
Die Set Size (mm nom.).....	50E-XX
Swaging Range (mm with Std. Die Set).....	16 to 78
(mm with Optional Dies).....	7 to 100
Max. Die Set Opening (mm + Die Set Size).....	50
Radial Swaging Force (kN).....	4,100
Cycle Speed (Full Stroke-Complete Cycle sec.).....	15

Physical:

Dimensions (Plan mm x mm x Height mm).....	600 x 420 x 650
Weight (Without Dies & Oil kg).....	260
Shipping Space (m x m x m).....	0.144
Shipping Weight (kg).....	290
Crate Size (Plan m x m x Height m).....	0.72 x 0.55 x 0.78

Electrical:

Supply (Volts / Amps).....	110 - 220 VAC / 30 - 15
Phase (No.).....	1
Power (kW).....	1.8
Electric Motor Speed (RPM @ 50 Hz).....	2880
Control Power (Volts).....	24 VDC

Hydraulic:

Rated Pressure (bar).....	300
Pump Flowrate (l/min).....	4.6
Reservoir Capacity (litres).....	10
Filtration (um).....	100

Installation:

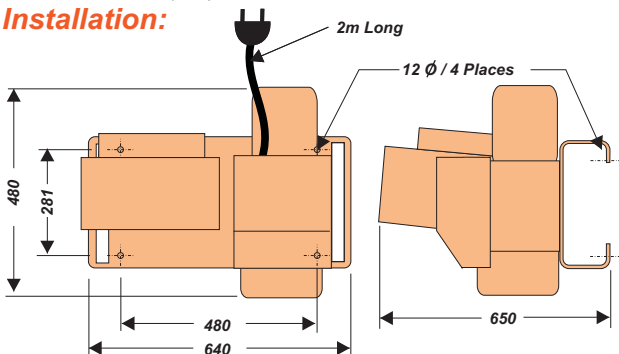

Specifications May Change Without Notice
All Dimensions in Millimeters.

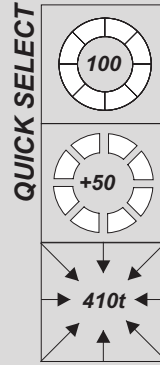

Options:

BS50ESDS Standard Die Set

11 Die Sets supplied as a package to allow infinite swaging between 16 to 78mm finished swage size. Each Die Set is supplied in a container that will provide for automatic charging of the BS50EQCT Quick Change Tool.

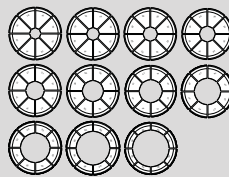

50E- Extended Range & Special Profile

The Extended Range of Die Sets Available are as follows:
 50E-6.5.....6.5 to 8mm finished swage.
 50E-8.....8 to 10mm finished swage.
 50E-10.....10 to 12mm finished swage.
 50E-12.....12 to 14mm finished swage.
 50E-14.....14 to 16mm finished swage.
 50E-76.....76 to 84mm finished swage.
 50E-84.....84 to 92mm finished swage.
 or consult your Dealer for special profile.

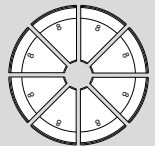

BS50EQCT Quick Change Tool

The Patented Quick Change Tool provides for changing of the Dies in the "Open" state. Therefore not requiring the Swage Press to "Close" & "Open". Dies are supplied in containers that will provide for automatic charging of this tool.

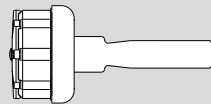

BSFP Foot Pedal

The Foot Pedal allows the operator to have his hands free while operating the press. It also provides for the press to go into "Fully Automatic" mode with Auto Retract to a specified Open Diameter set on the control panel. Provides for fast/repetitive operation.

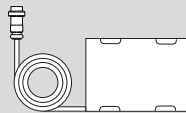

BS350DS Depth Stop

The Depth Stop provides Quick Exact positioning of the hose assembly. Excellent for high volume/repetitive work. It has a Pneumatic Spring which allows for length growth during the swaging process without damage to the coupling.

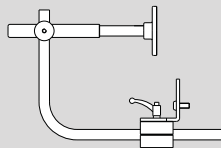

BS50EQCR Quick Change Rack

The BS50EQCR Quick Change Rack can be mounted against the wall or bolted into the BS-CAPRI Height Adjustable Stand. It has 9 rosettes in which to stock your 50E Type Die Sets as well as a position to locate the BS50EQCT Quick Change Tool. 1 x BS50EQCT Quick Change Tool included.

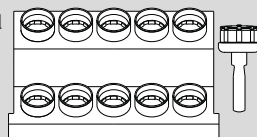

BS-CAPRI Height Adjustable Stand

The BS-CAPRI Height Adjustable Stand allows the Swage Press to be mounted at the most ergonomic height in relation to operator height. The Stand also accepts the BS50QCR Quick Change Rack and BS50QCT Quick Change Tool to complete the package. A Shelving Unit is also supplied to store various items.

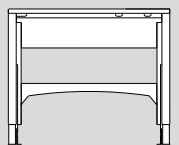

BETASWAGE PTY LTD
 A.B.N. 51 090 663 737
 38 DRAKE BLVD, ALTONA 3018
 P.O. BOX 390 WILLIAMSTOWN
 MELBOURNE 3016
 PH. 61 - 3 - 9369 0022
 FAX. 61 - 3 - 9369 4422
 email. sales@betaswage.com.au
 web. www.betaswage.com.au